

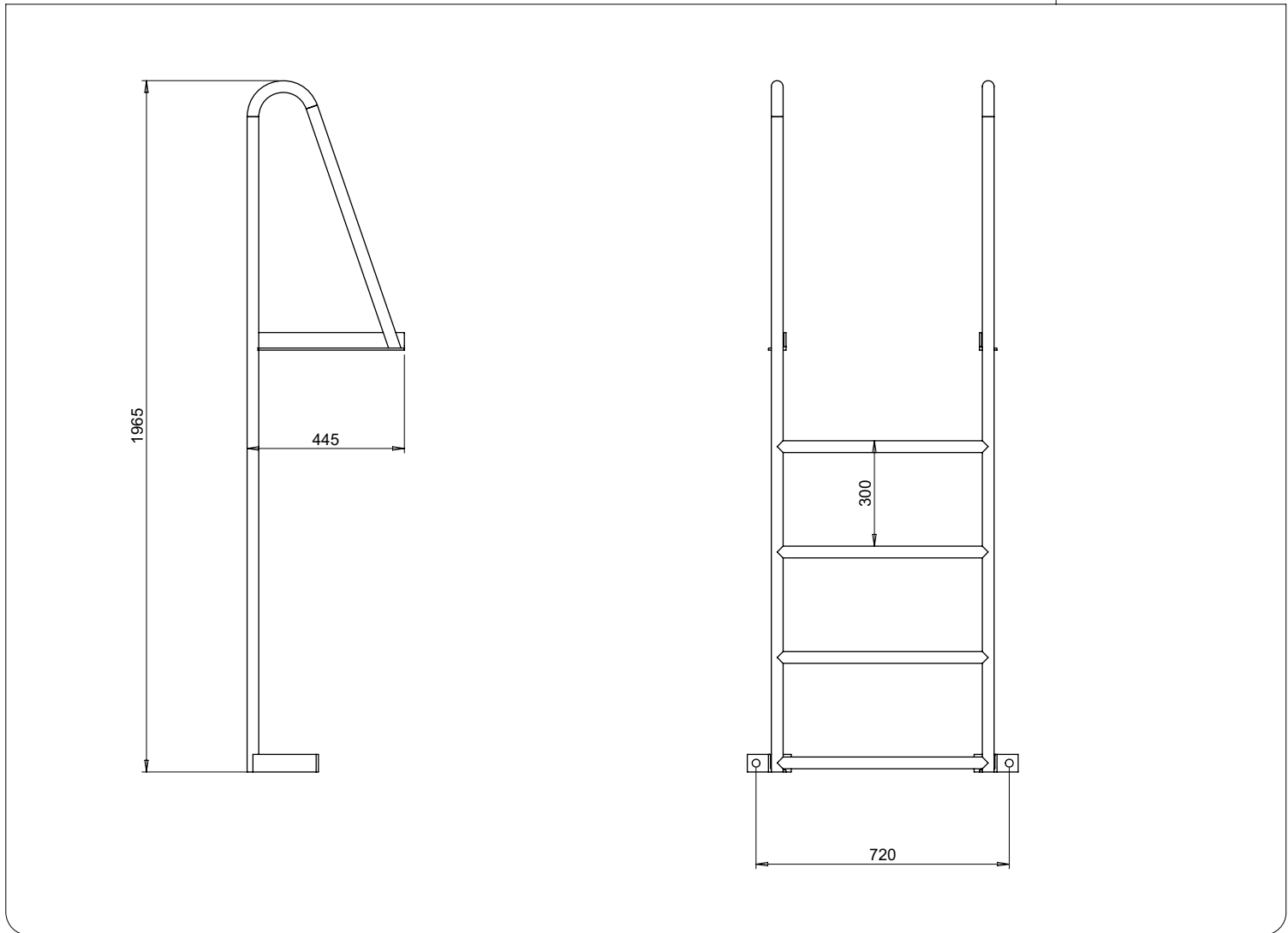

PART No: TWPDL-4

Thorworld Loading Bay Ladders are permanent fixtures designed to allow personnel to climb easily up and down the dock. Includes heavy-duty rungs with anti-slip finish and pre-drilled fixing holes to allow easy installation.

MATERIAL	MILD STEEL
WEIGHT	16 Kg
ESTIMATED LEADTIME	3 - 4 Weeks
DECK HEIGHT RANGE	1250mm-1500mm
No. of Rungs	4



All dimensions shown are in millimetres and are intended for reference purposes only; exact product measurements may vary due to applied tolerances and methods of manufacture

