

PART No: DLFR-8

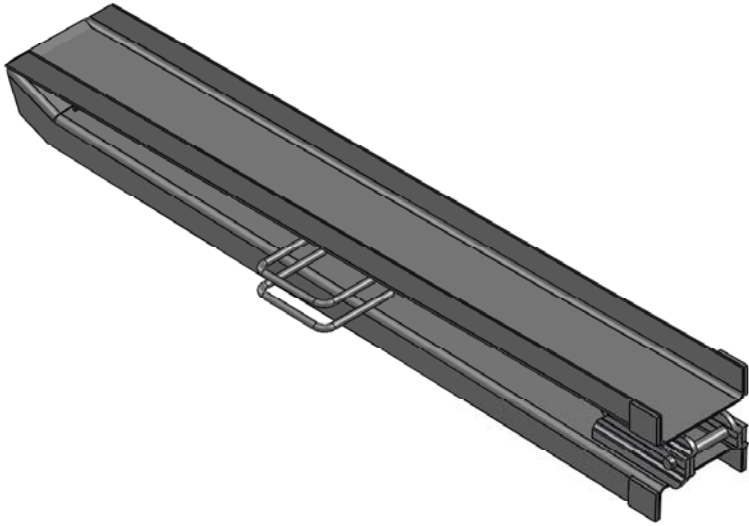

PRODUCT SHOWN IN THE FOLDED POSITION

Specifically designed for wheelchair users, a pair of Folding Ramps provides an easy to store and transport, lightweight solution to access for wheelchairs to buildings, shops, offices and transport. All ramps are rated at an axle load capacity of 250Kg per pair, which covers most applications including electric and manual wheel chairs.

MATERIAL	ALUMINIUM	
WEIGHT	19 Kg	
ESTIMATED LEADTIME	2 - 3 Weeks	
HEIGHT DIFF. (mm)	MAX. POSS. (mm)	MAX. RECOM. (mm)
	800	300

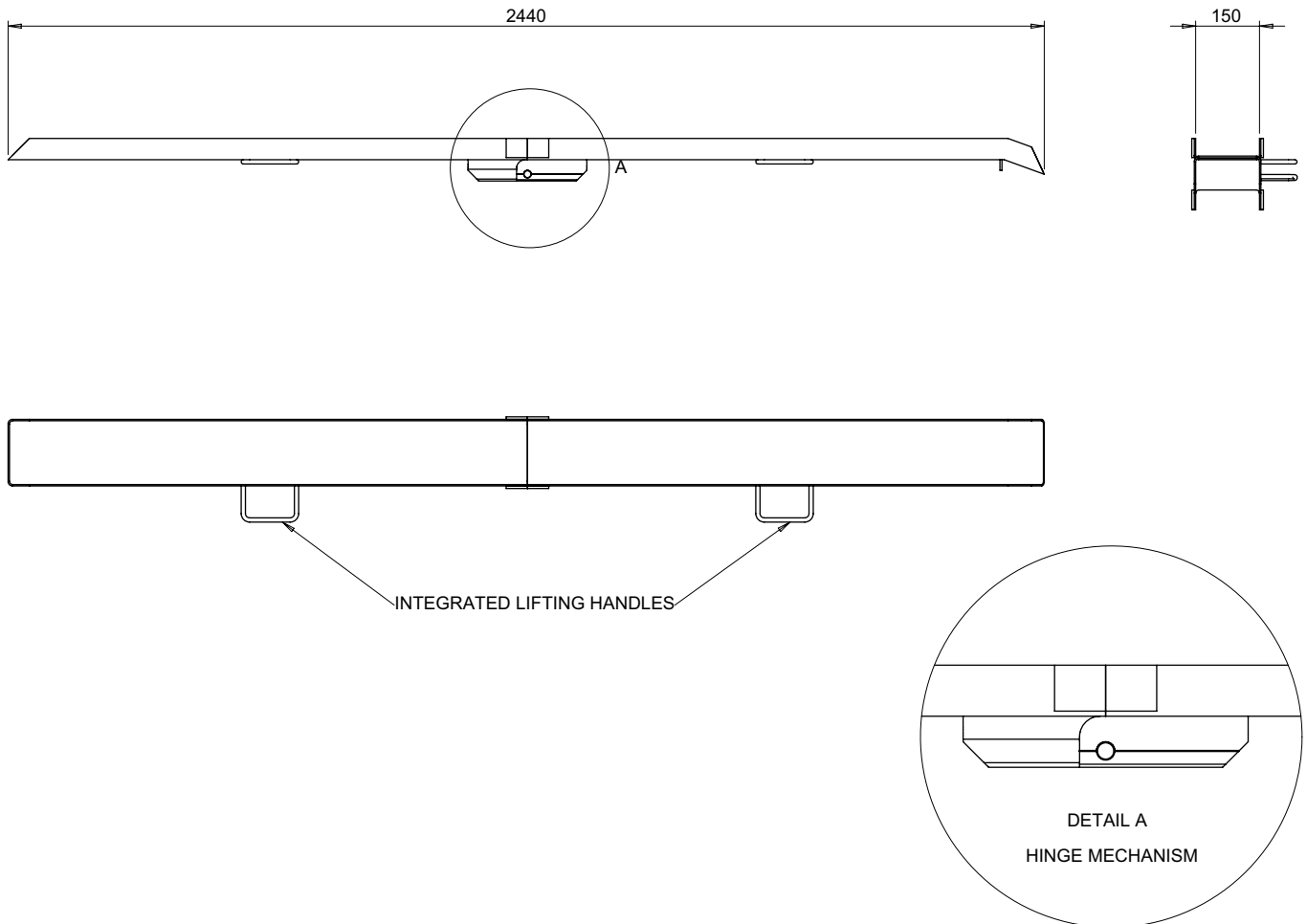

All dimensions shown are in millimetres and are intended for reference purposes only; exact product measurements may vary due to applied tolerances and methods of manufacture

